

NON-INVERTING PREAMP / DISCRIMINATOR / DIVIDER

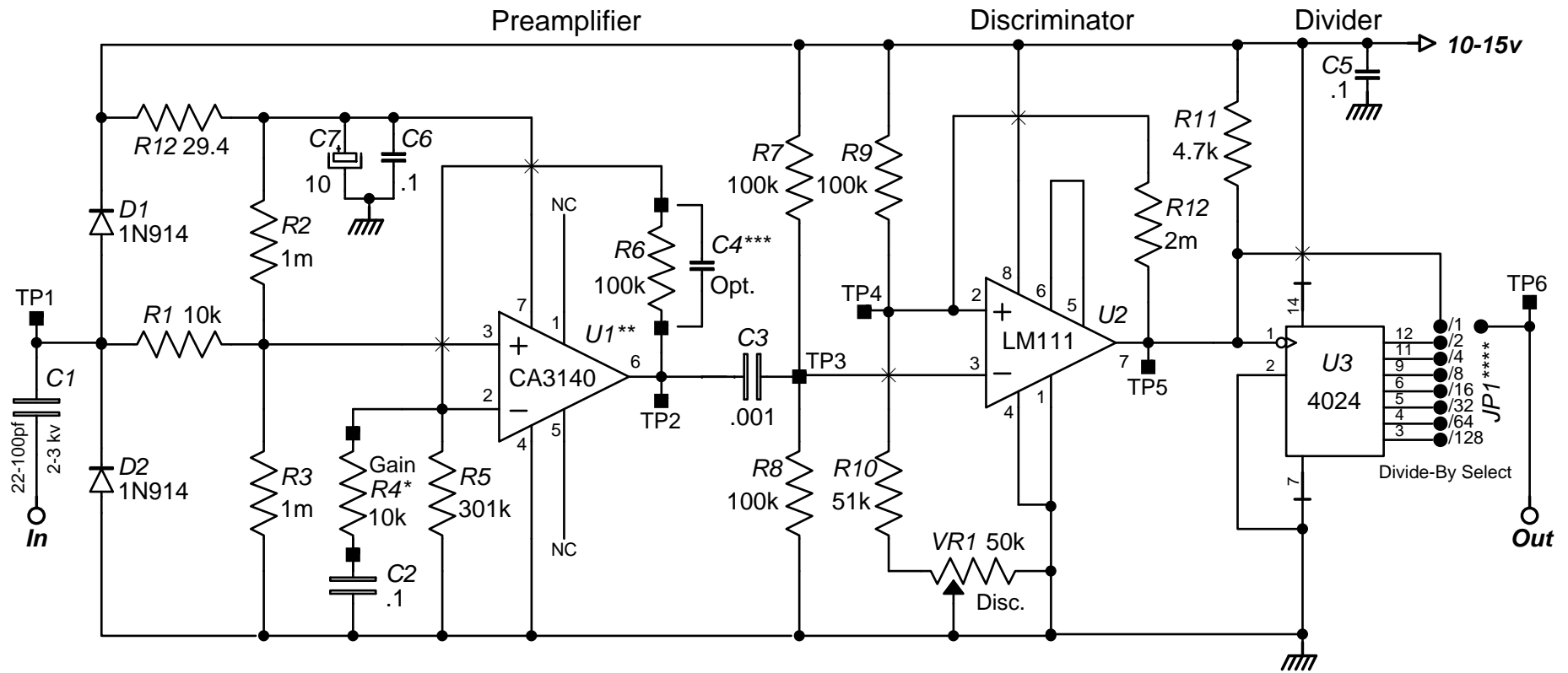

Copyright 2007 by AnaLog Services, Inc. All rights reserved.
 Reproduction is unlawful without express written permission.

NOTES:

- * R4 trial values: 10k for scintillation (x10), 2.2k for neutron (x50).
- ** Use LF157 or equivalent for He-3 neutron detectors.
- *** C4 not required for CA3140; may be required with other devices.
- **** Gamma /1 or /2, G-M /1, Neutron /2 or /4, 4 pi /8, Tracer /8 or /16

AnaLog Services, Inc.

1169 Haynesville Rd. - Reynolds Station, KY 42368 (270) 276-5671 Fax: (270) 276-5588

Preamp / Disc. / Divider

DHPDD1.sch

Sheet Size: A

Creation Date: 07/31/2007

Drawn By: Syd H. Levine

Revision: 1.0

Modify Date: 11/16/2009

Sheet 1 of 1